

Final Report
Data Acquisition Box

By

Gene Bender

DeSmet Jesuit High School

July 25, 2003

Contents

Overview	2
A Hybrid LBNL Cosmic Ray Detector	2
The Detectors	6
Changing PMT Voltage	7
Comparator Threshold of the LBNL Counter.....	8
Wiring Schematic.....	9

Overview

During the summer of 2003 I had the opportunity to work with cosmic ray detectors. Using detectors that were constructed this summer, data was collected using different data acquisition methods . This report summarizes what I have done in terms of building a data acquisition box utilizing a Lawrence Berkley National Laboratory (LBNL) cosmic ray detector circuit board and a simple 4 digit counter mounted together in a box for easy student and teacher use. It also summarizes technical information discovered about the LBNL circuit board and our detectors. Our goal was to utilize the features incorporated into the LBNL circuit board while expanding the possibilities.

A Hybrid LBNL Cosmic Ray Detector

The LBNL cosmic ray detector consists of two detectors and a data acquisition circuit board. The detectors and circuit board are mounted in a wooden box. The counter has the ability to count cosmic rays from one detector or to count cosmic rays that strike two detectors in coincidence. Other features on the LBNL circuit board include a 3 digit counter and 5 volt outputs for PMTs. (For complete information on the LBNL cosmic ray detectors go to [http://www.lbl.gov/abc/cosmic/.](http://www.lbl.gov/abc/cosmic/))

The LBNL circuit board has a 3 digit counter. When counts run greater than 1000, the thousands digit must be counted by hand. In order to overcome this problem, we added a 4 digit decade counter to our detector providing a millions digit. The LBNL board and the 4 digit counter were mounted together in a box. (See Figure 1) In order to allow a teacher to use the 4 digit counter for other activities that don't involve counting cosmic rays, both the input for the 4 digit counter and the overflow output for the thousands digit from the LBNL circuit are external to the box. (See Figure 3) If these two connections are connected the 4 digit counter will count the overflow from the LBNL board. Otherwise a connection can be made to just the 4 digit counter when such a need arises.

In order to allow many different kinds of experiments to be performed it was decided that that the two detectors needed to be free to move independently from one another. Experiments such as changing the vertical distance between the detectors or changing the amount of scintillator overlap, or the amount of horizontal distance between the detectors require that the detectors can be easily moved. To make this easy to do the DAQ box has external connections for the 5 volts needed to power the PMTs and the input signals from the detectors. The length of wire used to connect the detectors to the DAQ box can be increased as desired.

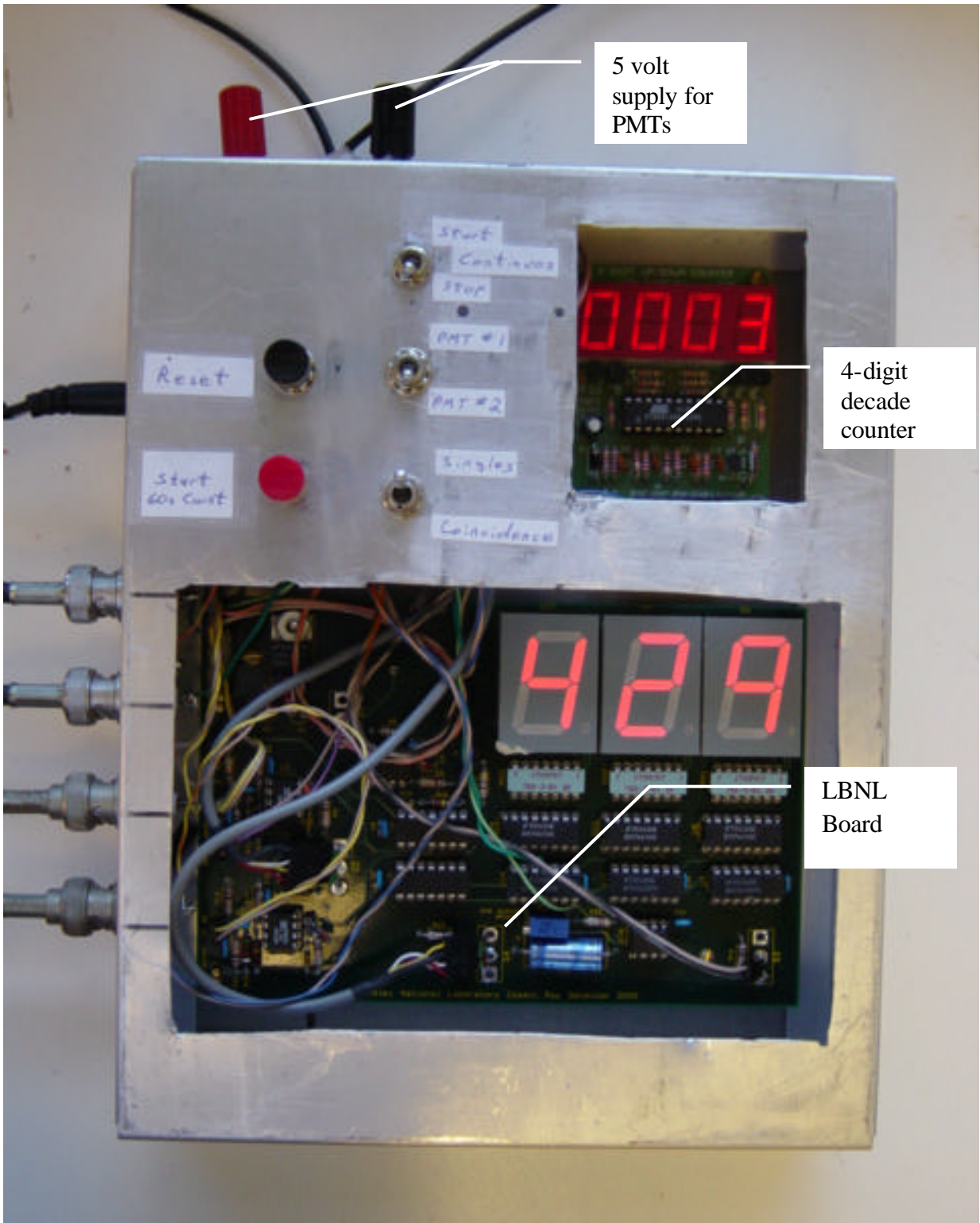

Figure 1 – Top view of box

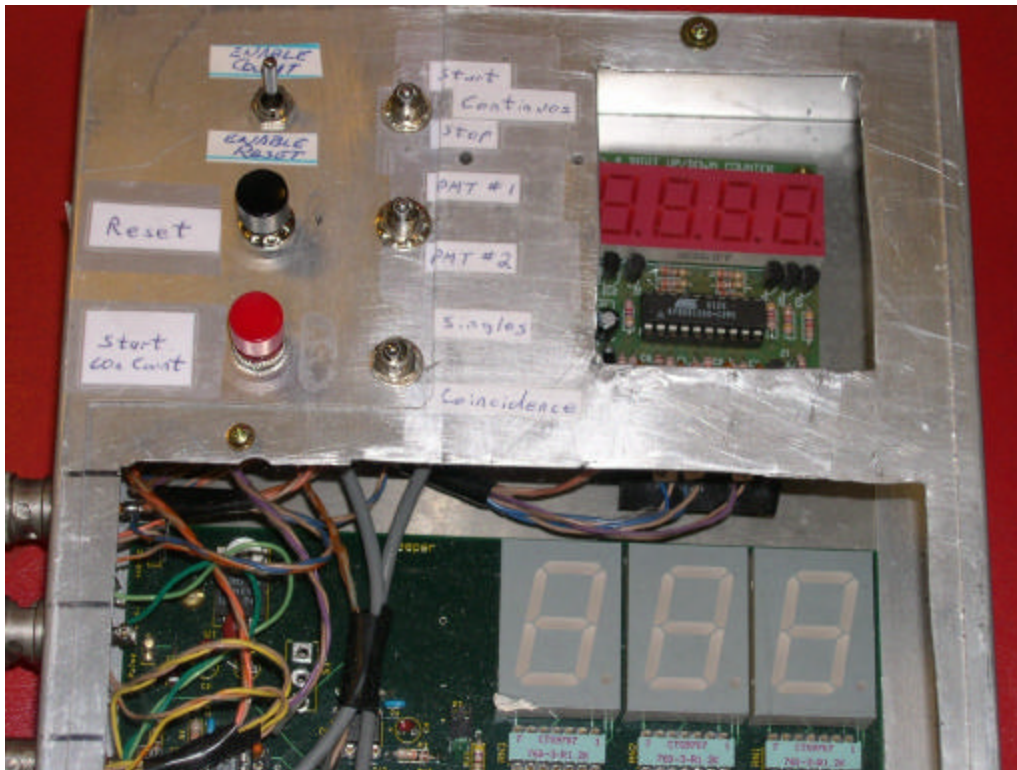

Figure 2 – Buttons & Switches

Button or Switch	Function
Enable Count/Enable Reset	Enable Count allows counter to count; Enable reset allows both counters to be set to zero.
Reset	Resets both counters to zero.
Start 60 sec Count	Begins a 60 sec count. Once started the 60-second timer cannot be stopped.
Continuous Start – Stop	This switch allows you to start or stop counting. If the 60 second counter has been started this switch is
PMT #1 – PMT #2	This switch allows you to choose which PMT you wish to count.
Singles – Coincidence	If this switch is the single mode then the counter is triggered by either PMT #1 or PMT #2. If the switch is in coincidence mode then the counter is triggered by both PMTs.

Power Supply
AC/DC
converter

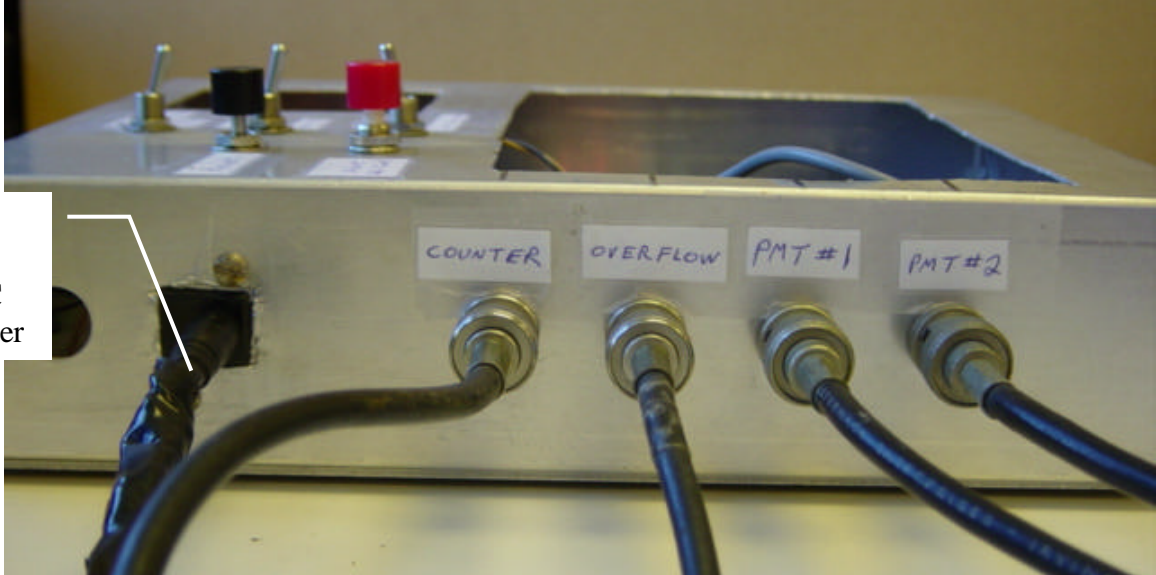

Figure 3 – Side View

Port	Function
Counter	Input for the 4-digit decade counter.
Overflow	Output - When the LBNL board rolls over 999 an output signal is sent out the overflow.
PMT #1	Input for PMT #1 signal.
PMT #2	Input for PMT #2 signal.

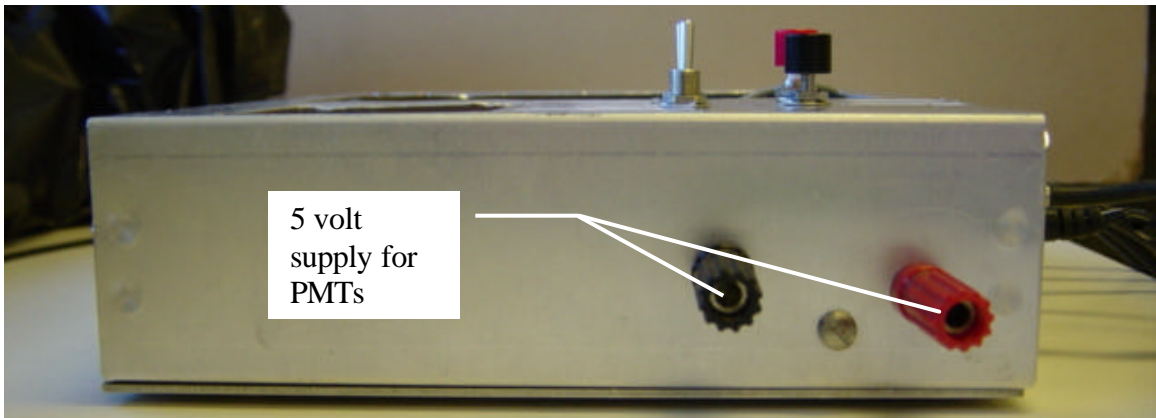

Figure 4 –Side View

The Detectors

Each detector consisted of a scintillator plate glued to a light guide. The light guide was then connected to a photomultiplier tube with a silicon cookie. The photomultiplier tube was not glued to the light guide so that the photomultiplier can be changed if you wish to do so. The detectors used originally had 2 inch photomultiplier tubes connected to them but they were changed to 1 inch photomultiplier tubes.



Figure 5 - Detector

Changing the PMT Voltage

To measure the photomultiplier tube voltage connect a voltmeter between ground and the yellow & white twisted wire coming out the back of the PMT. The PMT voltage is 1000 times this voltage reading. To change the voltage use a small screwdriver to turn the adjustment screw in the back of the PMT. (See Figure 6)

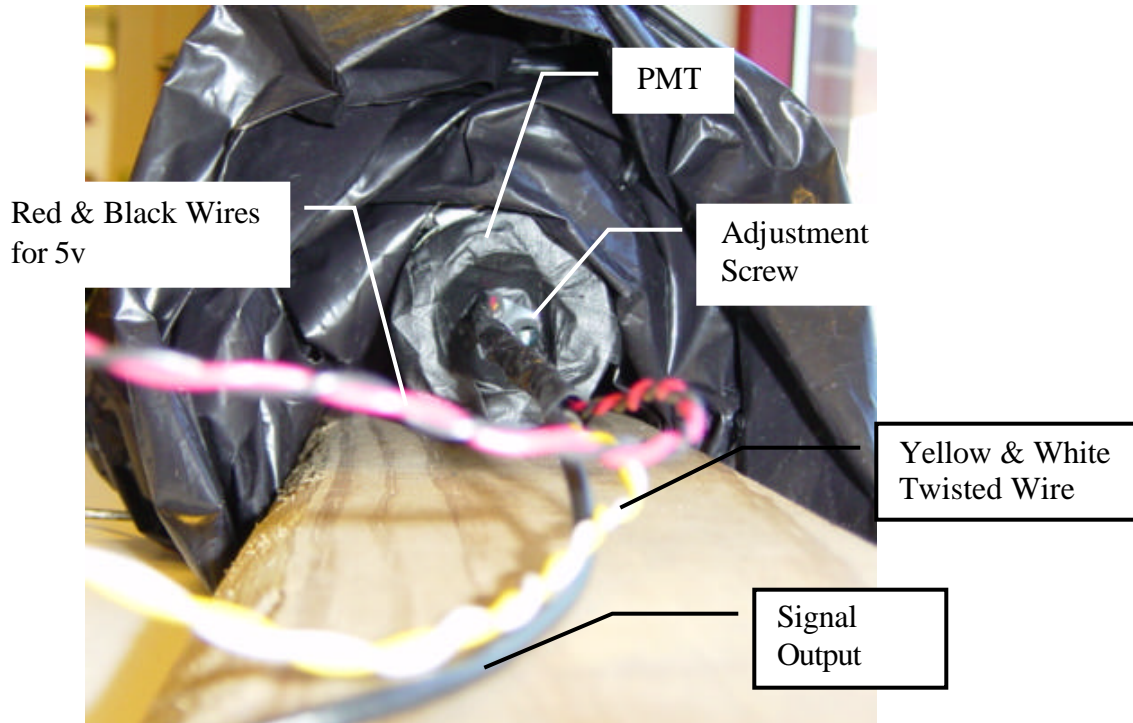

Figure 6 – Back of PMT

Comparator Threshold of the LBNL Counter

In order to determine how large of a pulse is needed to trigger the LBNL counter the following experiment was conducted. Pulses of varying magnitude were connected to the LBNL DAQ board to see if the counter would count them. All of the pulses were 70ns long.

Input Signal (mV)	Counter was triggered
40	Yes
20	Yes
10	Yes
5	No

Table 1

A 10mV signal is necessary to trigger the LBNL counter.

In order to determine how long of a pulse is needed to trigger the LBNL counter the following experiment was conducted. Pulses of varying length were connected to the board to see if the counter would count them. All of the pulses were 10 mV signals.

Input Signal Length (ns)	Counter was triggered
70	Yes
40	Yes
25	Yes
10	Yes

Table 2

A 10ns pulse will trigger the LBNL counter, but due to limitations of the equipment used we were unable to determine just how short the signal could be and still trigger the counter. We were unable to measure a signal less than 10ns using an oscilloscope. This may have been due to the limits of the scope or the function generator.

Our experiment showed that the comparator threshold of the LBNL counter is a 10mV signal that is 10ns long.

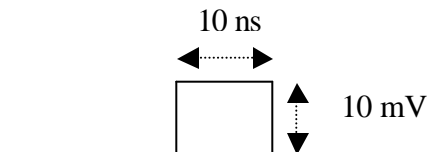

Figure 7 – Comparator Threshold

Wiring Schematic

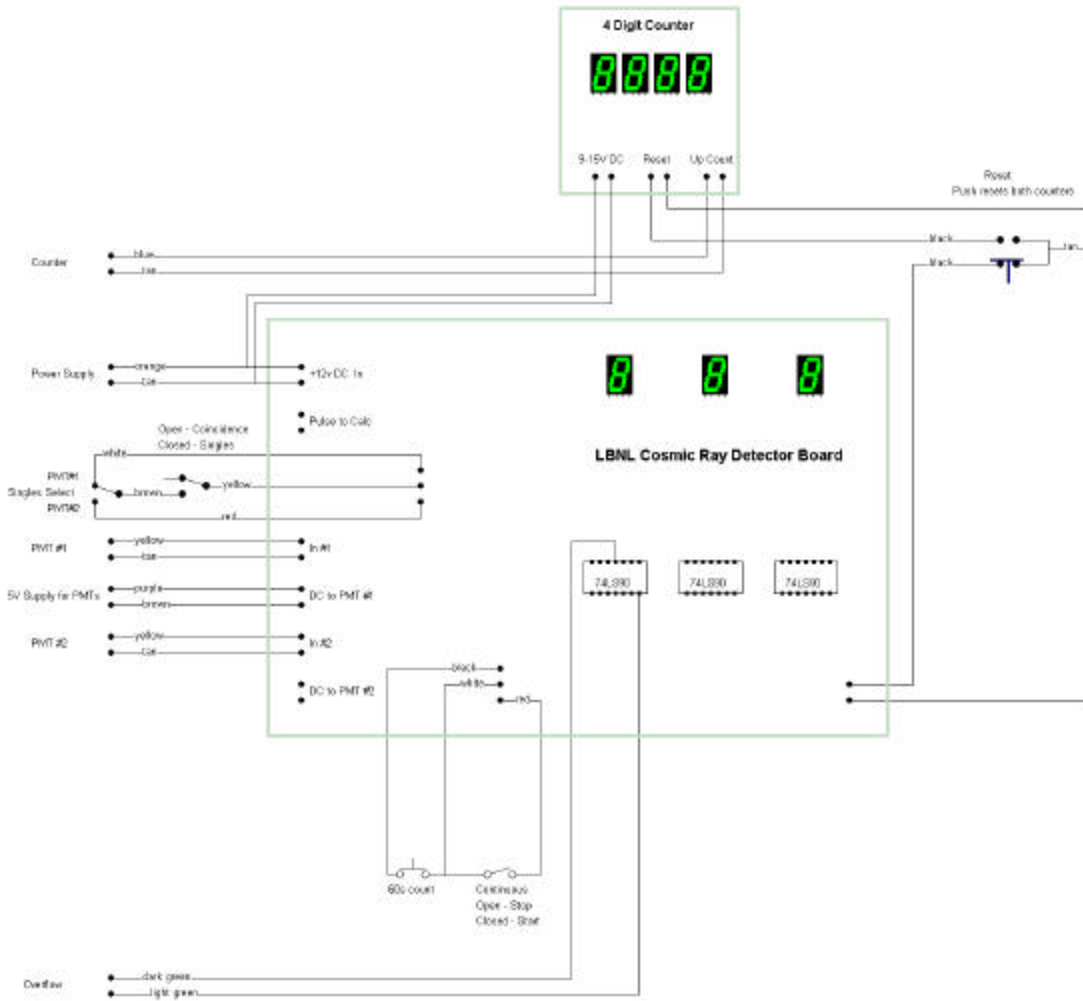

Figure 8 – Wiring Schematic